

SENSORES  
FONTES ALIMENTAÇÃO  
FITAS LED  
PERFIL COM LED  
PERFIL COM ÂNGULO  
PERFIS  
FOCOS LED  
PONTOS DE CONEXÃO  
LUZ DE EXPOSITORES

# FONTES DE ALIMENTAÇÃO





SENSORES

FONTES ALIMENTAÇÃO

FITAS LED

PERFIL COM LED

PERFIL COM ÂNGULO

PERFIS

FOCOS LED

PONTOS DE CONEXÃO

LUZ DE EXPOSITORES

# FONTE DE ALIMENTAÇÃO DE TENSÃO CONSTANTE GAMA STANDARD

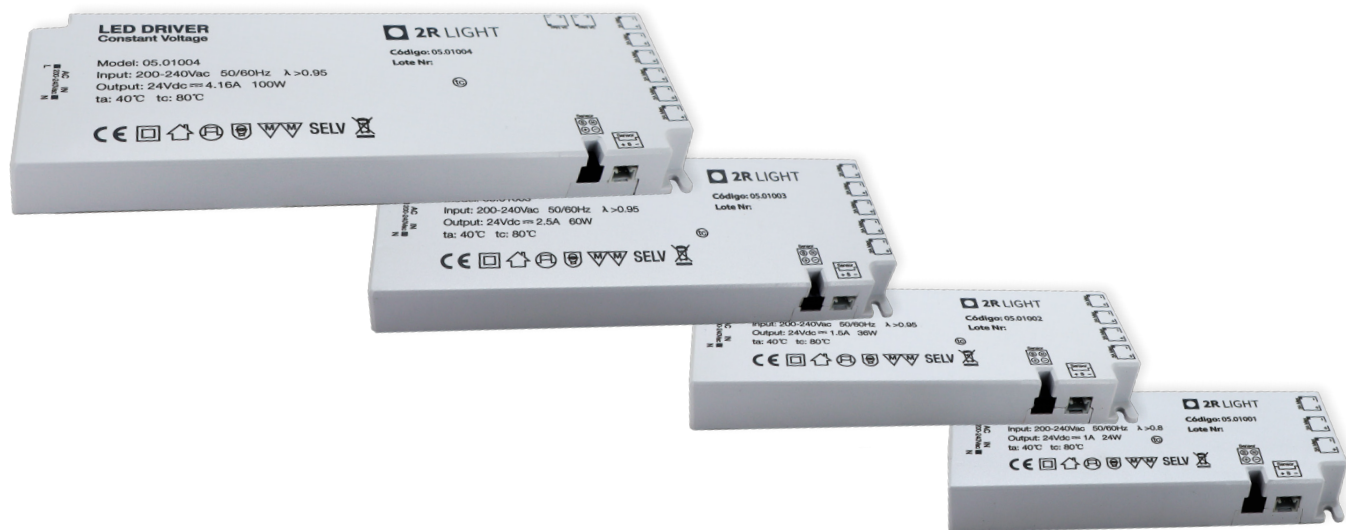

Modelo	Tamanho	Tensão de Entrada	Tensão de Saída	Potencia Máxima	Certificação
05.01001	124,7x45,1x18,5mm	222-240Vac	DC24V	24W	LVD
05.01002	144,1x50,3x18mm	222-240Vac	DC24V	36W	EMC
05.01003	171,8x61,4x18mm	222-240Vac	DC24V	60W	ROHS
05.01004	201,3x71,2x18mm	222-240Vac	DC24V	100W	REACH WEEE ERP



05.01001

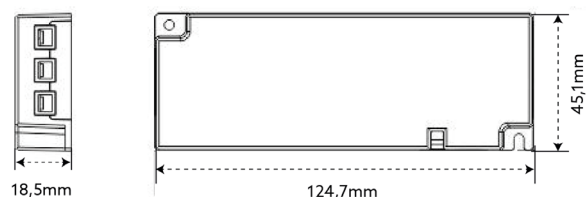

05.01003

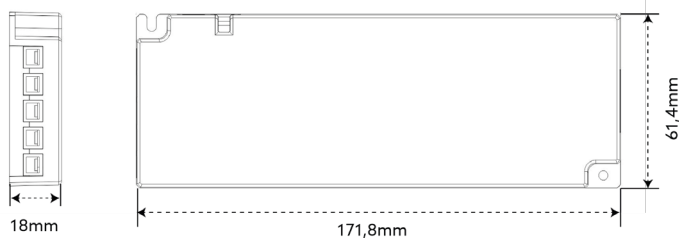

05.01002

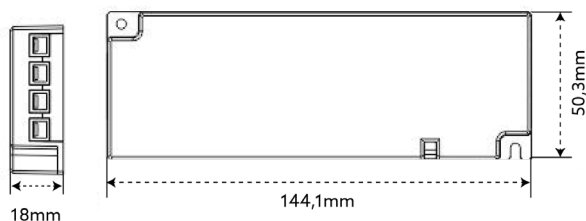

05.01004

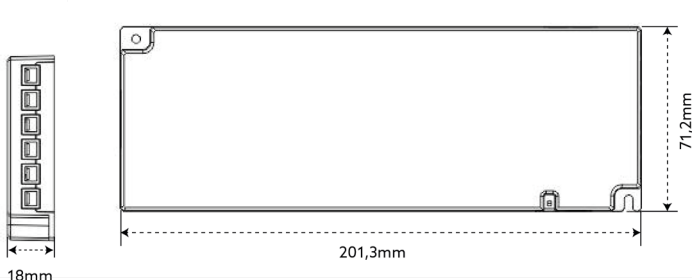

# FONTE DE ALIMENTAÇÃO DE TENSÃO CONSTANTE GAMA PRO



Modelo	Tamanho	Tensão de Entrada	Tensão de Saída	Potencia Máxima	Portas de saída	Tamanho cabo
05.01005	130x78x19mm	AC220V-240V 50/60Hz	DC24V	24W	6 Portas de controlo DuPont separadas	1.5m
05.01006	130x78x19mm	AC220V-240V 50/60Hz	DC24V	36W	6 Portas de controlo DuPont separadas	1.5m
05.01007	170x78x19mm	AC220V-240V 50/60Hz	DC24V	60W	8 Portas de controlo DuPont separadas	1.5m
05.01008	237x78x19mm	AC220V-240V 50/60Hz	DC24V	100W	8 Portas de controlo DuPont separadas	1.5m

CE RoHS

05.01005 e 05.01006

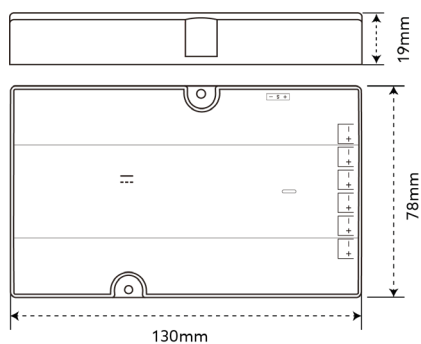

05.01007

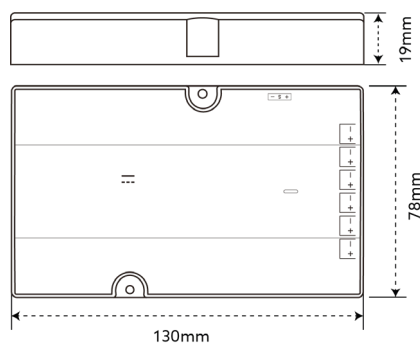

05.01008

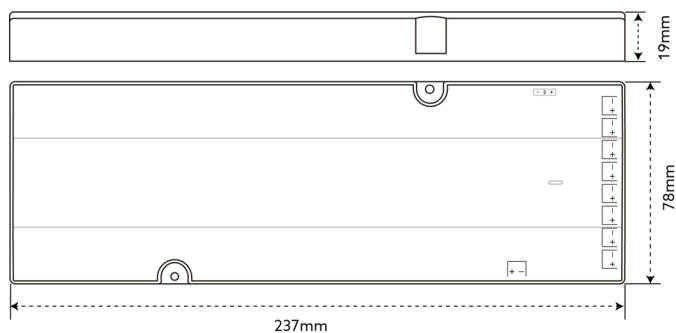

## CABLAGEM DE CONTROLE SEPARADA

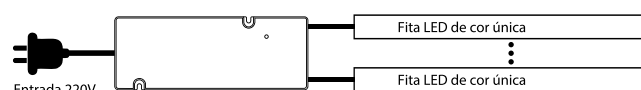

## CABLAGEM DE CONTROLE MESTRE

